

注：原理图中注释说明设计时需特别注意

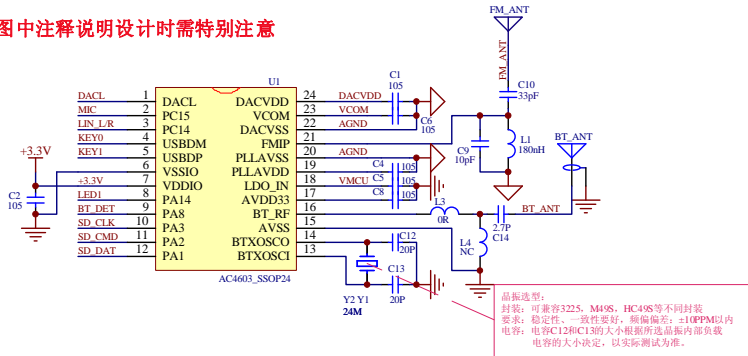

MCU

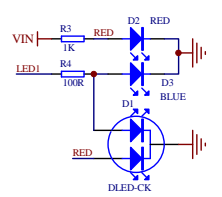
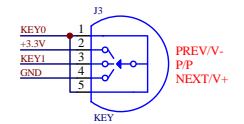
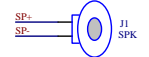
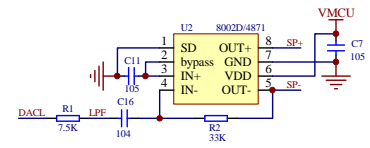

Key、LED

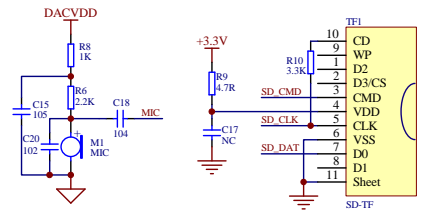

MIC、TF-CARD

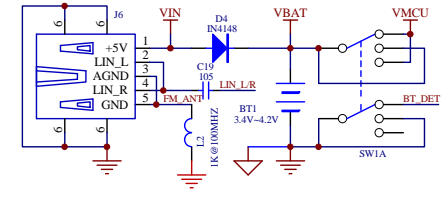

PA、Power