

● Package Dimensions

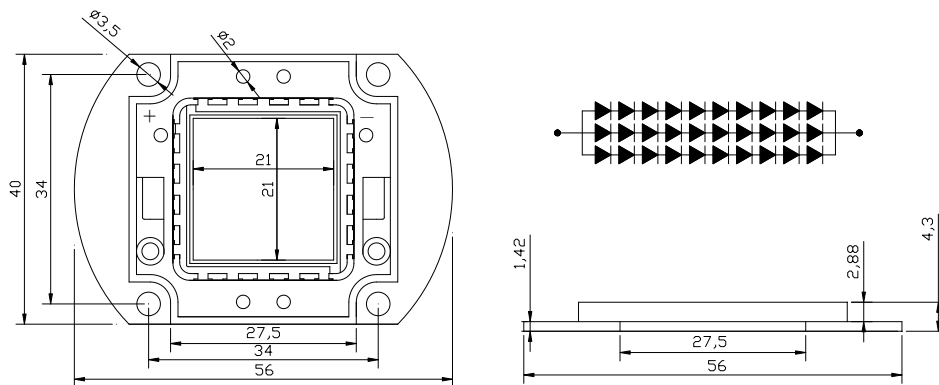

平面尺寸图 Dimension (mm)

Notes

1. All dimensions are in millimeters (inches).
2. Tolerance is $\pm 0.25\text{mm}$ (0.010") unless otherwise noted.
3. Protruded resin under flange is 1.0mm (0.04") max.
4. Lead spacing is measured where the leads emerge from the package.
5. Specifications are subject to change without notice.

● Spatial Distribution

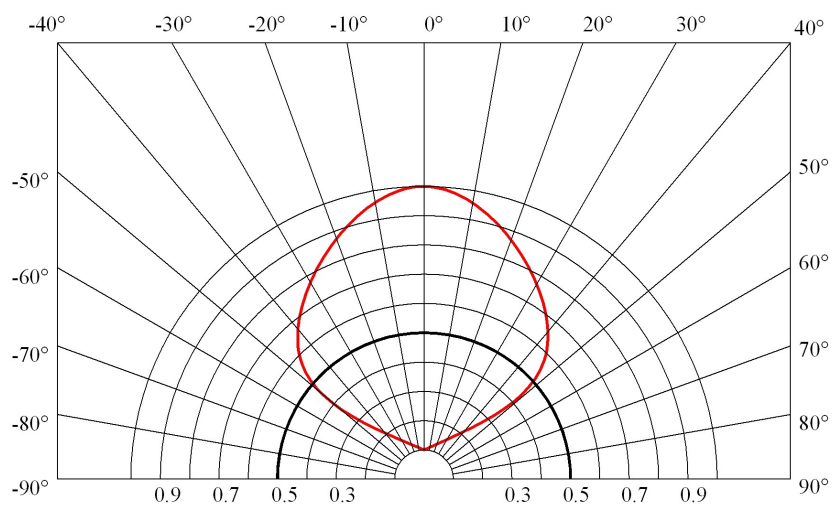

● **Electrical / Optical Characteristics at TA=25°C**

Parameter	Symbol	Min.	Typ.	Max.	Unit	Test Condition
Luminous Intensity	φ	2100	2300	2500	Lm	IF =1000mA
Viewing Angle	2θ1/2	95	100	105	deg	IF =1000mA
Dominant Wavelength	TC	6000	6500	7000	K	IF =1000mA
Forward Voltage	vF	31	33	35	v	IF =1000mA
Reverse Current	IR	0		10	uA	IF =1000mA

● **Absolute Maximum Ratings at TA=25°C**

Parameter	Maximum Rating
Power Dissipation	30W
Peak Forward Current(1/10 Duty Cycle, 0.1ms Pulse Width)	2000mA
Continuous Forward Current	1000mA
Derating Linear From 30°C	0.07mA/°C
Reverse Voltage	5V
Operating Temperature Range	-20°C to + 80°C
Storage Temperature Range	-30°C to + 100°C
Lead Soldering Temperature [1.6mm(.063") From Body]	260°C for 5 Seconds

